

Part No:	GH-12050
Holding Capacity:	91Kg
Bar Opens:	95°
Handle Opens:	60°
Weight:	0.16Kg
Spindle Supplied:	FC-14134

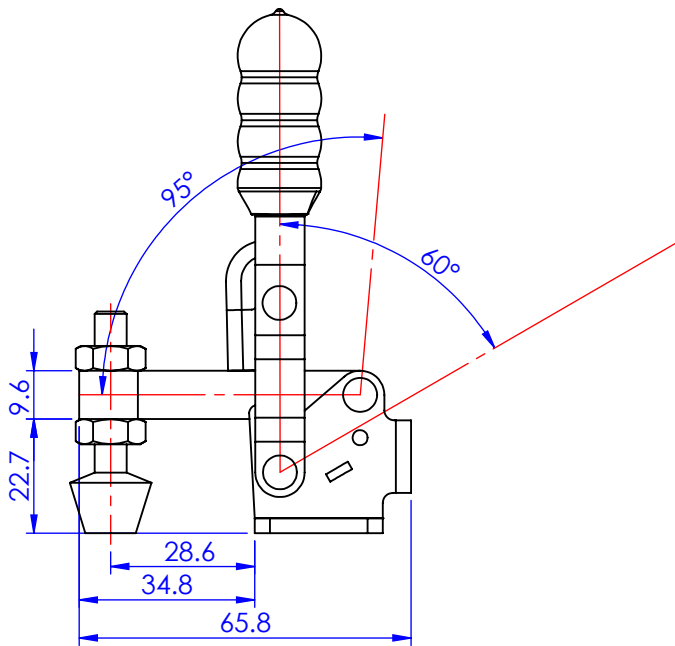

Unit:mm

Scale: 1:1.5

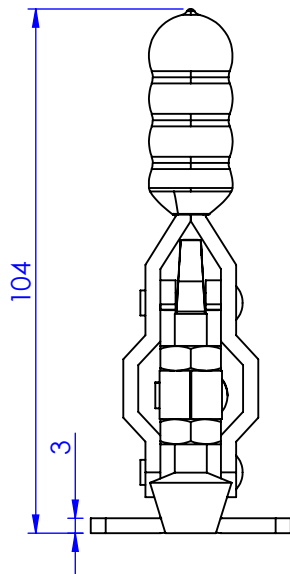
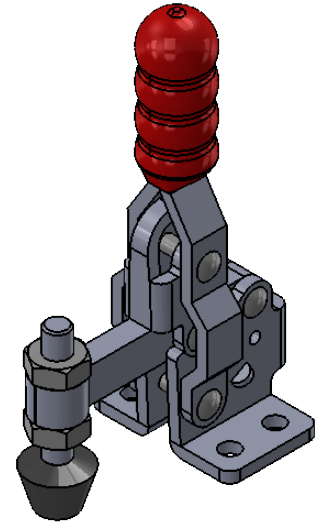
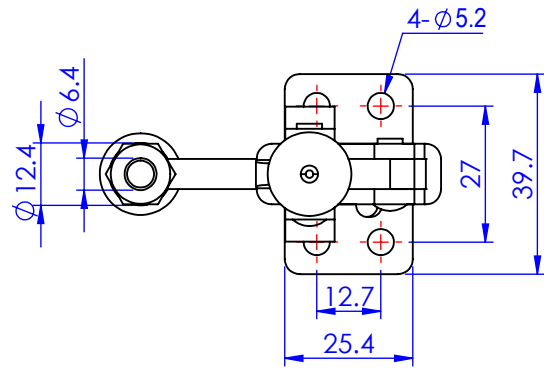

Good Hand Enterprise Co., Ltd

TITLE:		
DWG NO.	GH-12050	A4